

Umschalter MLS mit Nullstellung

4-POLIG / 25 - 125 A

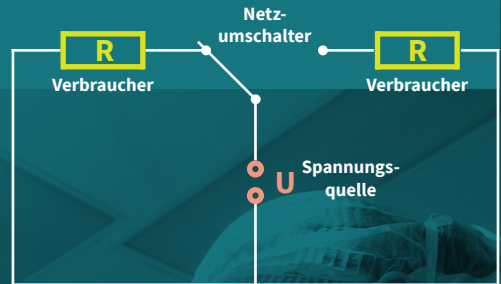

60947-3



entspricht der international gültigen Norm IEC 60947-3



Switch to Quality!

TECHNISCHE DATEN

MLS-Schalter			025	025	040	040	063	063	080	080	100	100	125	125
			4VU3B	4VU	4VU3B	4VU	4VU3B	4VU	4VU3B	4VU	4VU3B	4VU	4VU3B	4VU
Brücke N-Modul			nein	ja	nein	ja	nein	ja	nein	ja	nein	ja	nein	ja
Nennspannung U _e	V AC		690	690	690	690	690	690	690	690	690	690	690	690
Bemessungsstoßspannungsfestigkeit U _{imp}	kV		6	6	6	6	6	6	8	8	8	8	8	8
Bemessungsdauerstrom I _u / I _{th} / I _{the}	A		25	25	40	40	63	63	80	80	100	100	125	125
Kurzschlußfestigkeit Max. Sicherung	gL		25	25	40	40	63	63	80	80	100	100	125	125
Bedingter Bemessungskurzschlußstrom	kAeff		15	15	15	15	-	-	25	25	25	25	25	25
Bemessungskurzschluß-einschaltvermögen I _{cm}	kA		-	-	-	-	1,8	1,8	-	-	-	-	-	-
Isolationseigenschaften entspricht EN 60947	bis zu ... V AC		690	690	690	690	690	690	1000	1000	1000	1000	1000	1000
Schaltwinkel			90°	90°	90°	90°	90°	90°	90°	90°	90°	90°	90°	90°
Kontakte (Strompfade)	max		8	8	8	8	8	8	8	8	8	8	8	8
Anschlußquerschnitt														
- ein- bzw. - mehrdrähtig	min max	mm ² mm ²	1 10	1 10	1 10	1 10	6 25	6 25	4 50	4 50	4 50	4 50	4 50	4 50
- flexibel oder mehrdrahtig mit Hülse	min max	mm ² mm ²	0,75 6	0,75 6	0,75 6	0,75 6	4 16	4 16	2,5 35	2,5 35	2,5 35	2,5 35	2,5 35	2,5 35
Amerikanische Drahtnorm	AWG		8	8	8	8	4	4	1/0	1/0	1/0	1/0	1/0	1/0
Nennbetriebsstrom I _e														
- AC-21A	A		25	25	40	40	63	63	80	80	100	100	125	125
- cUL	300V AC A		25	25	40	40	63	63	80	80	100	100	100	100
- General Use	600V AC A		25	25	40	40	63	63	80	80	100	100	100	100
Schaltvermögen bei 50-60Hz (3 Phasen)														
AC-23A	220-240V kW		4	4	7,5	7,5	15	15	18,5	18,5	22	22	30	30
	380-440V kW		7,5	7,5	15	15	22	22	30	30	37	37	45	45
	500V kW		7,5	7,5	15	15	22	22	30	30	37	37	45	45
	660-690V kW		7,5	7,5	15	15	22	22	30	30	37	37	45	45
AC-3	220-240V kW		3	3	5,5	5,5	11	11	15	15	22	22	30	30
	380-440V kW		5,5	5,5	11	11	18,5	18,5	22	22	30	30	37	37
	500V kW		5,5	5,5	11	11	18,5	18,5	30	30	37	37	45	45
	660-690V kW		5,5	5,5	11	11	18,5	18,5	22	22	30	30	37	37
cUL	110-120V ACHP		1,5	1,5	3	3	5	5	7,5	7,5	10	10	15	15
	208V AC HP		3	3	7,5	7,5	-	-	10	10	15	15	-	-
	220-240V ACHP		3	3	7,5	7,5	10	10	20	20	25	25	30	30
	440-480V ACHP		5	5	15	15	20	20	30	30	30	30	60	60
	550-600V ACHP		5	5	15	15	20	20	30	30	30	30	50	50

Anwendung:

Verteilereinbau Montage auf Hutschiene Standard 35 mm mit Abdeckplatte 45 mm Loch, Griff / Frontplatte schwarz / silber

Mechanische Lebensdauer: >10⁵ Schaltspiele

Klimafestigkeit: feuchte Wärme, konstant, bei DIN IEC 60068-2-78 / feuchte Wärme, zyklisch, bei DIN IEC 60068-2-30

Umgebungstemperatur: offen: -25/+50 °C. (min/max) / im Gehäuse: -25/+40 °C. (min/max)

Die Tragfähigkeit im intermittierenden Betrieb, Klasse 12 AB: 60%/40%/25% DF: 1.3/1.6/2 × I_e

Trennschalter, Produktlinie MLS 4-poliger Umschalter mit OFF-Schaltung Bodenmontage

Hutschiene mit Frontplatte 45 mm Loch, Montageform / Betätigung grau, Frontplatte silber, M-Griff schwarz

Normen IEC 60947, EN 60947, IEC 60204, EN 60204, ANSI/UL 60947-1, ANSI/UL 60947-4-1A

SCHALTBILDER

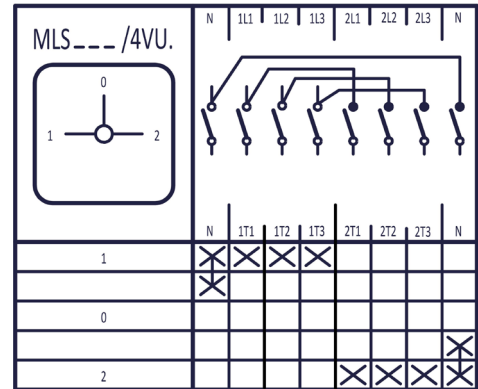
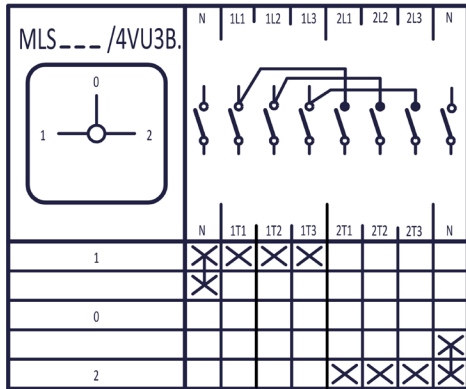

ABMESSUNGEN (MM/INCH)

Typ	N-Brücke	A1		A2		B		B1		B2		C		C1		C2		H	
		mm	inch	mm	inch	mm	inch	mm	inch	mm	inch	mm	inch	mm	inch	mm	inch	mm	inch
MLS-025	ja	45	1,77	76	2,99	72	2,83	84	3,31	96	3,78	40	1,57	51,5	2,03	25,5	1,0	70	2,76
MLS-025	nein	45	1,77	76	2,99	72	2,83	84	3,31	96	3,78	40	1,57	51,5	2,03	25,5	1,0	70	2,76
MLS-040	ja	45	1,77	76	2,99	72	2,83	84	3,31	96	3,78	40	1,57	51,5	2,03	25,5	1,0	70	2,76
MLS-040	nein	45	1,77	76	2,99	72	2,83	84	3,31	96	3,78	40	1,57	51,5	2,03	25,5	1,0	70	2,76
MLS-063	ja	45	1,77	105	4,13	100	3,94	119	4,69	138	5,43	40	1,57	51,5	2,03	25,5	1,0	72	2,83
MLS-063	nein	45	1,77	105	4,13	100	3,94	119	4,69	138	5,43	40	1,57	51,5	2,03	25,5	1,0	72	2,83
MLS-080	ja	45	1,77	72	2,83	140	5,51	159	6,26	178	7,01	67	2,64	48	1,89	16	0,63	80	3,15
MLS-080	nein	45	1,77	72	2,83	140	5,51	159	6,26	178	7,01	67	2,64	48	1,89	16	0,63	80	3,15
MLS-100	ja	45	1,77	72	2,83	140	5,51	159	6,26	178	7,01	67	2,64	48	1,89	16	0,63	80	3,15
MLS-100	nein	45	1,77	72	2,83	140	5,51	159	6,26	178	7,01	67	2,64	48	1,89	16	0,63	80	3,15
MLS-125	ja	45	1,77	72	2,83	140	5,51	159	6,26	178	7,01	67	2,64	48	1,89	16	0,63	80	3,15
MLS-125	nein	45	1,77	72	2,83	140	5,51	159	6,26	178	7,01	67	2,64	48	1,89	16	0,63	80	3,15

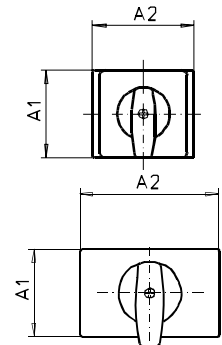
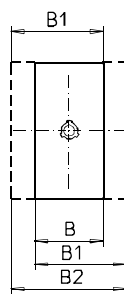
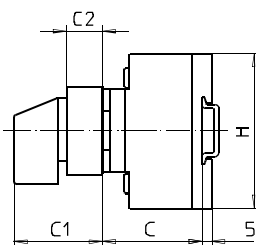
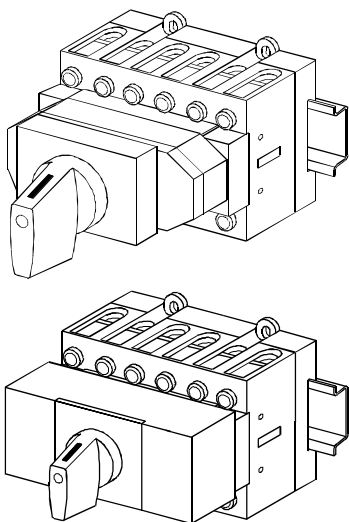

MERZ Schaltgeräte GMBH + CO KG

Kernerstraße 15
D-74405 Gaildorf

Telefon +49 (0) 7971 252-252
Fax +49 (0) 7971 252-351

info@merz-schaltgeraete.de
www.merz-schaltgeraete.de



switch to Quality!